



PICO & PICOone

USER MANUAL

V2.1

PICO & PICOone

© 2022 SIMARINE

All rights reserved. No parts of this work may be reproduced in any form or by any means - graphic, electronic, or mechanical, including photocopying, recording, taping, or information storage and retrieval systems - without the written permission of the publisher.

Products that are referred to in this document may be either trademarks and/or registered trademarks of the respective owners. The publisher and the author make no claim to these trademarks.

While every precaution has been taken in the preparation of this document, the publisher and the author assume no responsibility for errors or omissions, or for damages resulting from the use of information contained in this document or from the use of programs and source code that may accompany it. In no event shall the publisher and the author be liable for any loss of profit or any other commercial damage caused or alleged to have been caused directly or indirectly by this document.

| | |
|---|-----------|
| 1. Introduction | 11 |
| 1.1 About | 12 |
| 1.2 Schematics | 13 |
| 2. Accessories | 15 |
| 3. Safety | 17 |
| 4. Declaration of conformity | 19 |
| 5. Installation | 21 |
| 5.1 PICO mounting | 22 |
| 5.1.1 PICO standalone | 22 |
| 5.1.2 PICO panel-mount | 24 |
| 5.2 Connecting | 26 |
| 5.2.1 Connecting different shunts | 26 |
| 6. Basic Setup | 27 |
| 6.1 Settings Screen | 29 |
| 6.2 Start screen after first connection | 30 |
| 6.3 Language settings | 30 |
| 6.4 Units | 30 |

| | | |
|------------|---|-----------|
| 6.5 | Battery configuration | 31 |
| 6.5.1 | Add new battery | 31 |
| 6.6 | Tank configuration | 32 |
| 6.6.1 | Add new Tank | 32 |
| 6.7 | Displaying battery, tank, temperature, barograph, inclinometer measurements and alarms | 33 |
| 6.7.1 | Batteries screen | 34 |
| 6.7.2 | Tanks screen | 35 |
| 6.7.3 | Temperatures screen | 36 |
| 6.7.4 | Barograph screen | 36 |
| 6.7.5 | Inclinometers screen | 37 |
| 6.7.6 | Alarm screen | 37 |
| 6.8 | Device configuration | 38 |
| 6.8.1 | General settings | 38 |
| 6.8.1.1 | Screen | 39 |
| 6.8.1.1.1 | Auto brightness | 39 |
| 6.8.1.1.2 | Brightness | 39 |
| 6.8.1.1.3 | Min. brightness | 39 |
| 6.8.1.2 | Device | 40 |
| 6.8.1.2.1 | Auto sleep | 40 |
| 6.8.1.2.2 | Sleep after | 40 |
| 6.8.1.2.3 | Sleep screen | 40 |
| 6.8.1.2.4 | Battery | 40 |
| 6.8.1.2.5 | Left button | 41 |



| | | |
|-------------|-----------------------------|----|
| 6.8.1.2.6 | Power management | 41 |
| 6.8.1.3 | Language | 41 |
| 6.8.1.4 | Units | 41 |
| 6.8.2 | Data management | 41 |
| 6.8.3 | Devices | 42 |
| 6.8.3.1 | Batteries | 42 |
| 6.8.3.1.1 | Name | 43 |
| 6.8.3.1.2 | Type | 43 |
| 6.8.3.1.3 | Capacity | 43 |
| 6.8.3.1.4 | Voltmeter | 44 |
| 6.8.3.1.5 | Ammeters | 44 |
| 6.8.3.1.6 | Temperature sensors | 44 |
| 6.8.3.1.7 | Range | 44 |
| 6.8.3.1.8 | Advanced settings | 45 |
| 6.8.3.1.8.1 | Battery full settings | 45 |
| 6.8.3.1.9 | Instance | 46 |
| 6.8.3.1.10 | Delete | 46 |
| 6.8.3.2 | Tanks | 46 |
| 6.8.3.2.1 | Name | 47 |
| 6.8.3.2.2 | Type | 47 |
| 6.8.3.2.3 | Sensor type | 47 |
| 6.8.3.2.4 | Sensor | 47 |
| 6.8.3.2.5 | Capacity | 47 |



| | | |
|-----------|---------------------------|----|
| 6.8.3.2.6 | Calibration points | 47 |
| 6.8.3.2.7 | Display priority | 48 |
| 6.8.3.2.8 | Delete | 48 |
| 6.8.3.3 | Temperature sensors | 49 |
| 6.8.3.3.1 | Name | 49 |
| 6.8.3.3.2 | Type | 49 |
| 6.8.3.3.3 | Device | 49 |
| 6.8.3.3.4 | Display priority | 50 |
| 6.8.3.3.5 | Range MIN | 50 |
| 6.8.3.3.6 | Range MAX | 50 |
| 6.8.3.3.7 | Calibration | 50 |
| 6.8.3.3.8 | Delete | 50 |
| 6.8.3.4 | Current sensors | 50 |
| 6.8.3.4.1 | Name | 51 |
| 6.8.3.4.2 | Range | 51 |
| 6.8.3.4.3 | Reverse current | 51 |
| 6.8.3.4.4 | Add current | 51 |
| 6.8.3.4.5 | Battery | 52 |
| 6.8.3.4.6 | Display separately | 52 |
| 6.8.3.4.7 | Display priority | 52 |
| 6.8.3.4.8 | Device | 52 |
| 6.8.3.4.9 | Merge with | 52 |
| 6.8.3.5 | Voltmeters | 53 |



| | | |
|-----------|--------------------------|----|
| 6.8.3.6 | Ohmmeters | 53 |
| 6.8.3.7 | Coulomb counter | 53 |
| 6.8.3.8 | Inclinometer | 54 |
| 6.8.3.8.1 | Name | 54 |
| 6.8.3.8.2 | Style | 54 |
| 6.8.3.8.3 | Sensor | 54 |
| 6.8.3.8.4 | Nonlinear | 54 |
| 6.8.3.8.5 | Calibration | 55 |
| 6.8.3.8.6 | Display | 55 |
| 6.8.3.8.7 | Reverse | 55 |
| 6.8.3.8.8 | Delete | 55 |
| 6.8.3.9 | User Sensors | 55 |
| 6.8.3.9.1 | Name | 55 |
| 6.8.3.9.2 | Voltmeter | 55 |
| 6.8.3.9.3 | Range MIN | 55 |
| 6.8.3.9.4 | Range MAX | 55 |
| 6.8.3.9.5 | Decimals | 56 |
| 6.8.3.9.6 | Measurement unit | 56 |
| 6.8.3.9.7 | Low voltage point | 56 |
| 6.8.3.9.8 | High voltage point | 56 |
| 6.8.3.9.9 | Delete | 56 |
| 6.8.4 | WI-FI | 56 |
| 6.8.4.1 | Operation | 56 |

| | | |
|-----------|-----------------------|----|
| 6.8.4.2 | Mode | 56 |
| 6.8.4.2.1 | STA MODE | 56 |
| 6.8.4.2.2 | AP Mode | 57 |
| 6.8.4.3 | SSID | 58 |
| 6.8.4.4 | TCP IP | 58 |
| 6.8.4.5 | TCP PORT | 58 |
| 6.8.4.6 | UDP IP | 59 |
| 6.8.4.7 | UDP PORT | 59 |
| 6.8.4.8 | Password | 59 |
| 6.8.4.9 | WIFI reset | 59 |
| 6.8.5 | Date & Time | 59 |
| 6.8.5.1 | Time | 59 |
| 6.8.5.2 | Date | 59 |
| 6.8.5.3 | Time zone | 60 |
| 6.8.5.4 | Time format | 60 |
| 6.8.5.5 | Date format | 60 |
| 6.8.6 | Service | 60 |
| 6.8.6.1 | Settings locked | 60 |
| 6.8.6.2 | Main screen | 60 |
| 6.8.6.3 | Debug screen | 60 |
| 6.8.7 | System | 60 |

| | | |
|------------|--|-----------|
| 6.8.7.1 | Communication devices | 60 |
| 6.8.7.2 | System info | 60 |
| 6.8.7.3 | System reset | 61 |
| 7. | Mobile App | 63 |
| 8. | Save and restore settings | 67 |
| 9. | Firmware upgrade | 69 |
| 10. | Technical specifications | 71 |

1. Introduction

Congratulations on your purchase of the Simarine PICO Battery Monitor.

Simarine developed a state of the art DC Battery monitor. Simarine PICO is a water and dust resistant device used to monitor DC power sources as batteries and solar panels. The information is displayed on a large 3,5" high resolution IPS display with Gorilla® Glass and anti-reflective coating to ensure superior visibility.

- PICO is capable of monitoring up to 6 batteries, 14 tanks, 14 temperatures and 20 independent current sensors (Shunts). PICOone is capable of monitoring up to 2 batteries, 2 tanks, 2 temperatures and 20 independent current sensors (Shunts).
- PICO and PICOone are equipped with a Wi-Fi module to communicate with the PICO application available for Android™ and iPhone® smartphones. The app allows accessing live data, analyzing historical data, configuring PICO and perform a firmware upgrade of PICO.

1.1 About

In this manual we will show you how to install the PICO / PICOone and configure the settings.

You will find more information on other shunts, modules installations, devices, on the website: <https://simarine.net/manuals>

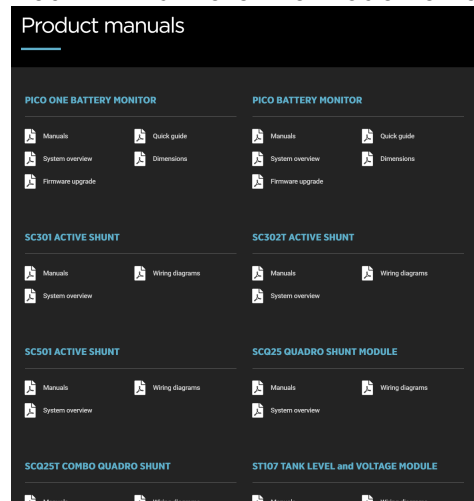

1.2 Schematics

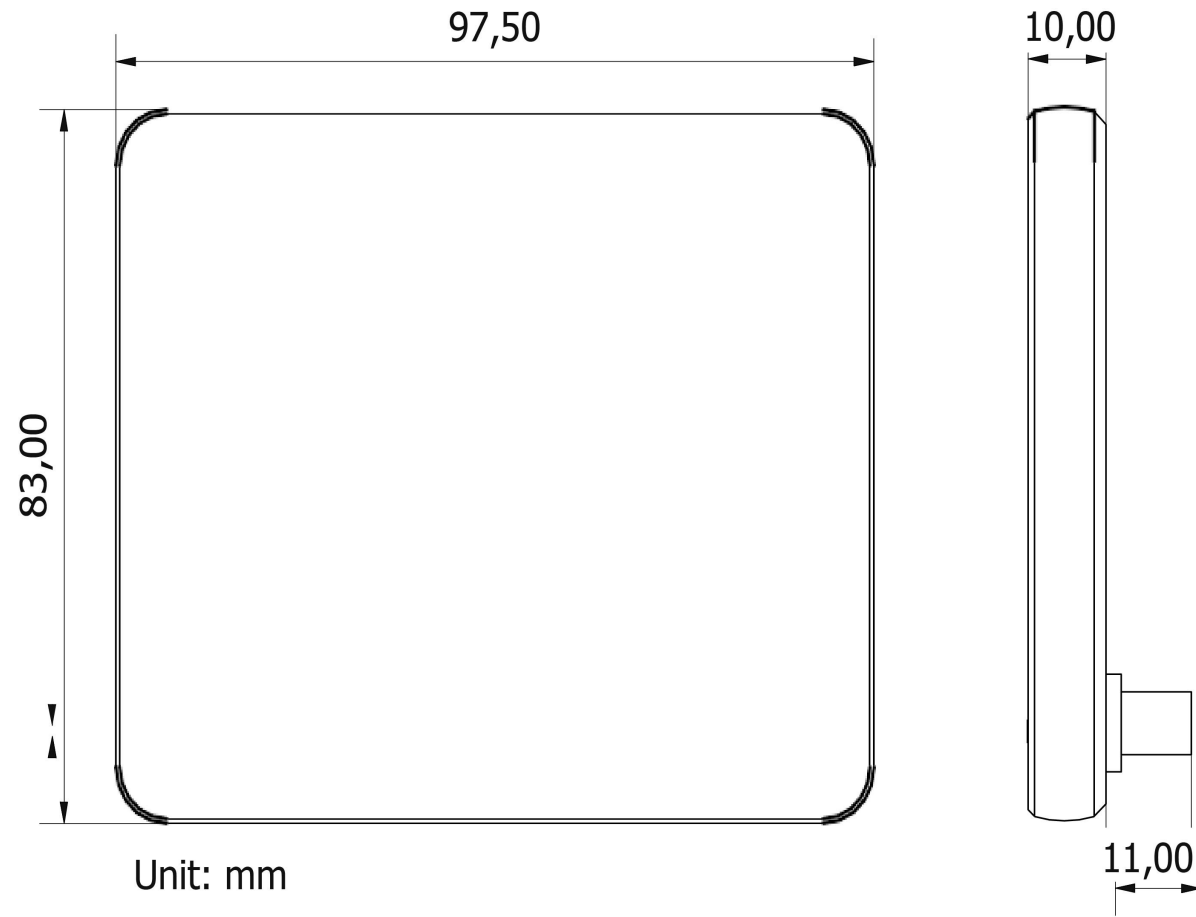

2. Accessories

SIMARINE PICO & PICOone is compatible with the following SIMARINE modules:

- **SC303** Digital Shunt – Simarine High Precision 300A Shunt, for up to 75V systems.
- **SC503** Digital Shunt – Simarine High Precision 500A Shunt, for up to 75V systems.
- **SDI01** Inclinometer – Simarine High-resolution digital inclinometer for pitch and roll with manual calibration.
- **SC302T** Digital Shunt – Simarine High Precision 300A Shunt with 2 resistance inputs for tank level measurement and 2 voltage inputs for measuring voltages of two batteries.
- **SCQ25** Quadro Digital Shunt Module – Simarine High Precision 4x25A Shunt, for 12V and 24V systems
- **SCQ50** Quadro Digital Shunt Module – Simarine High Precision 4x50A Shunt, for 12V and 24V systems.
- **SCQ25T** Quadro Digital Shunt and Tank Module – Simarine High Precision 4x25A Shunt and Tank Interface Module with 4 resistance and 3 voltage inputs.
- **ST107** Digital tank interface module with 4 resistance and 3 voltage Inputs.



3. Safety

Electrical specialists with proper safety equipment should make installation of Simarine electronics. When working with batteries, you should wear protective clothing and eye protection.

CAUTION: Batteries contain acid, a corrosive, colorless liquid that will burn your eyes, skin, and clothing. Should the acid come in contact with eyes, skin or clothing, wash it immediately with soap under fresh water for at least 15 minutes, and seek medical support immediately.

CAUTION: Do NOT connect anything to a damaged battery. It could heat up, catch fire or explode.

CAUTION: Lead-acid batteries can generate explosive gases during operation. Never smoke, allow flames or sparks near the battery. Make sure to keep sufficient ventilation around the battery.

CAUTION: When working with a battery, remove all personal metal items like watches, rings, necklaces, and bracelets. Metal items in contact with the battery terminals might cause a short circuit with a very high electric current, which may heat up and melt nearby objects and cause severe burns.



4. Declaration of conformity



MANUFACTURER: SIMARINE d.o.o.

ADDRESS: Ulica škofa Maksimilijana Držecnika 6,
SI-2000 Maribor, Slovenia, EU

Declares that the following product:

PRODUCT TYPE: PICO

Conforms to the requirements of the following Directives of the European Union:

EMC Directive 2014/30EU, RoHS Directive 2002/95/EC

The above product conforms with the following harmonized standards:

EN61000-6-3: 2001 EMC - Generic Emissions Standard,

EN61000-6-2: 2005 EMC - Generic Immunity Standard

5. Installation





5.1 PICO mounting

Simarine PICO should be installed in a visible place to provide good readability. Please note that ONLY the PICO/PICOone display unit is water and dust resistant! Any other modules including splitter shouldn't expose to high humidity or liquids in any case.

The mounting process and installation cutouts depend on the model, as described in following sections

5.1.1 PICO standalone

PICO Standalone version has dimensions of 98 x 84 x 10 mm (3.85 x 3.30 x 0.39 in) and needs NO installation cutout. The mounting process requires drilling of 5 (PICOone) or 6 (PICO) mounting holes and access to the rear of the mounting surface. In case you have NO rear access, you can bond it using supplied double sided tape.

-  1. Before drilling, check if there is enough space to mount your PICO.
-  2. Mark mounting holes using the supplied installation template.
-  3. *Drill all holes.*
-  4. *Connect the connector on the back side of PICO to the splitter cable (be sure to align the pins correctly) and fasten it by turning the safety ring clockwise.*
-  5. Finish mounting the PICO from the back side with the supplied threaded rod and nuts. Screws, rods and nuts MUST be fastened by hand. Excessive force may damage the threads on PICO.

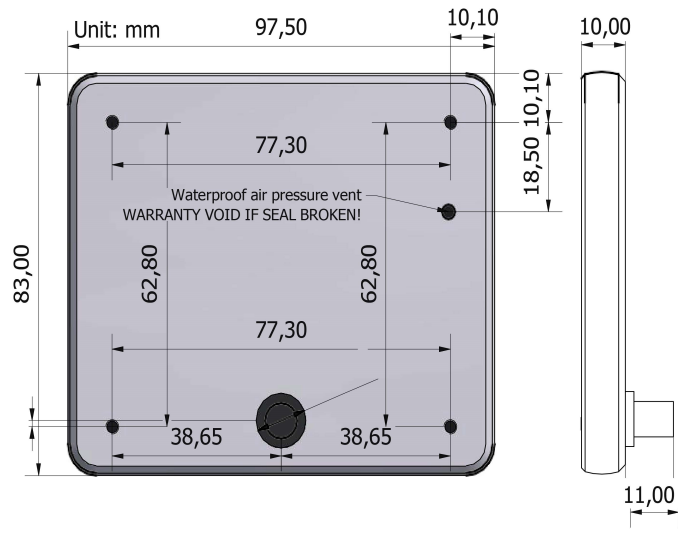

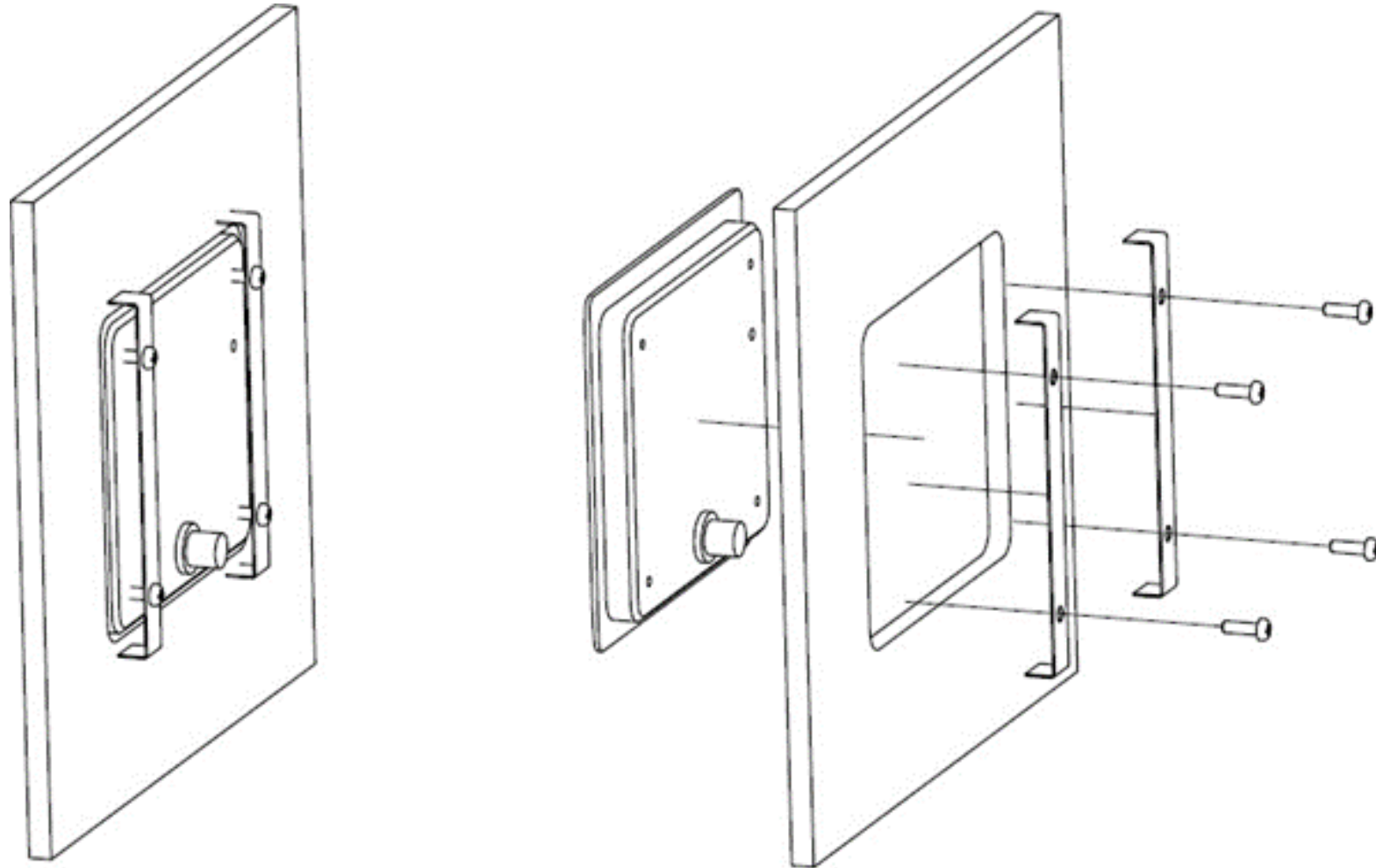





5.1.2 PICO panel-mount

PICO Panel-mount version dimensions are 108.5 x 94 x 10 mm (4.27 x 3.70 x 0.39 in). It needs an installation cutout of 98 x 83mm. It can be mounted with supplied threaded rods and brackets or bonded with adhesive if there is no rear access to the mounting surface.

Steps to be taken for proper mounting:

1.  Before cutting out, check if there is enough space for your PICO.
2.  Mark the cutout line with the supplied installation template.
3.  Using a saw, carefully cut out the marked area
4.  *Connect the connector on the back side of PICO to the splitter cable (be sure to align the pins correctly) and fasten it by turning the safety ring clockwise.*
5.  Finish mounting the PICO from the back side with the supplied threaded rod and nuts. Screws, rods and nuts **MUST** be fastened by hand. Excessive force may damage the threads on PICO.

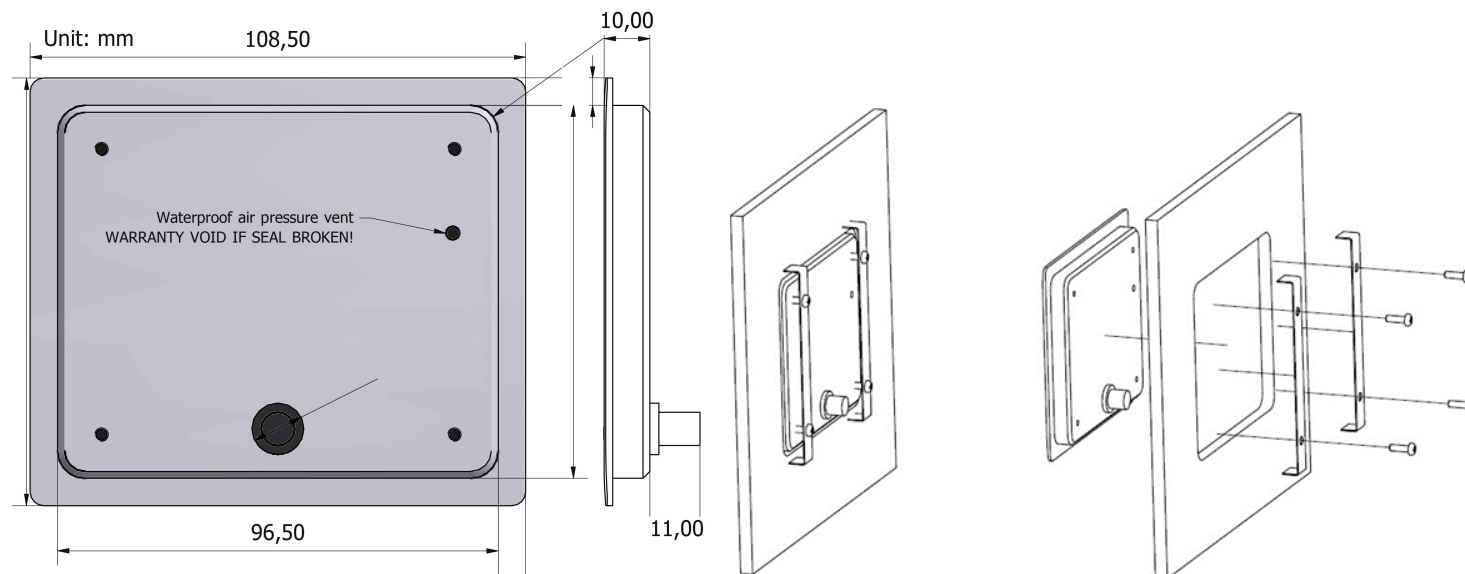

5.2 Connecting

Power cable - Minimum power cable cross-section requirement at a maximal temperature of insulation: 70 °C (160 °F).

| Continuous current | Cable cross-sectional area |
|--------------------|----------------------------|
| 500 A | 220 mm ² |
| 400 A | 150 mm ² |
| 300 A | 95 mm ² |
| 200 A | 50 mm ² |
| 100 A | 25 mm ² |

CAUTION: Failure to observe the required cable cross-sections can damage the shunt, wiring, or cause a fire.

SiCOM data cable - For the SiCOM connection use the supplied cable. If not possible, use the following table to determinate the right cable type.

| Cable length | Cable type |
|--------------|--|
| < 5m | No limitations |
| >= 5m | 2 x 2 x 0.25mm ² Twisted pair (recommended) |

PICO connects to the SiCOM bus **via attached Splitter**, which is a SiCOM bus entry point for other devices and the power connection. Splitter must connect to the power source (6-35V) with the red/black cable. It is recommended to connect the power cable behind the main switch, so you can power off the complete system, although the total power consumption of the system is very low (usually <100mA at normal operation).

5.2.1 Connecting different shunts

You can find the information of all the latest Simarine Digital shunts / modules on the website:

- <https://www.simarine.net/manuals>

6. Basic Setup

PICO's menu management is transparent and easy to use. All changes can be done using four touch buttons below the screen. Menus and settings on the picture below can differ from the menus and settings on your device since future firmware upgrades might cause some minor changes in the menus and settings.

Long press  button to enter the settings menu.



6.1 Settings Screen

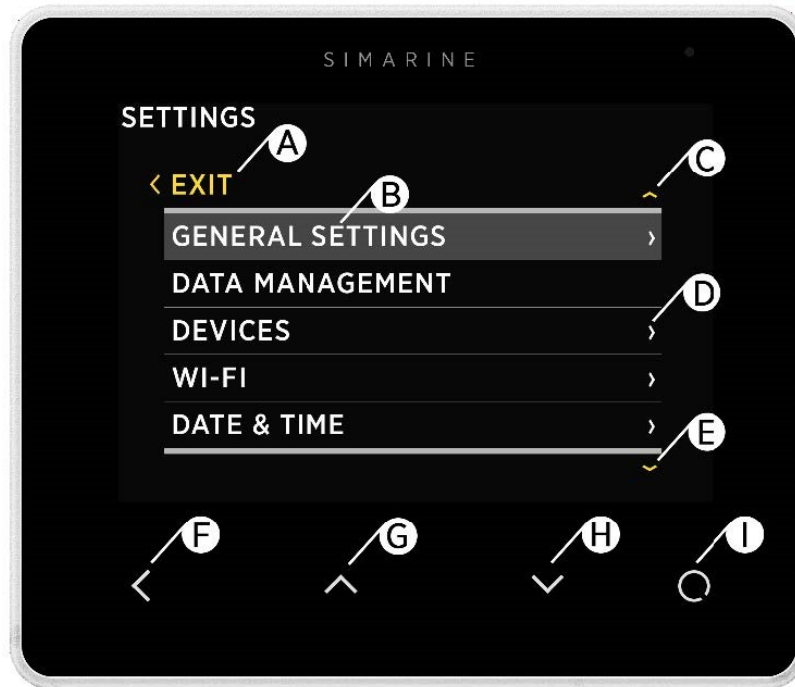

- A - Label indicates current position in the menu.
- B - Currently selected item.
- C - Arrow indicates there is at least one more menu item in the arrow direction.
- D - Arrow indicates there is a submenu.
- E - Arrow indicates there is at least one more menu item in the arrow direction.
- F - **BACK BUTTON**, is used to navigate one level back or leave the settings menu.
- G - **UP BUTTON** is used to navigate up in the menu or changing value or switching screens in live view.
- H - **DOWN BUTTON** is used to navigate down in the menu or changing value or switching screens in live view.
- I - **ENTER BUTTON**, long press activates settings, short press commits changes or enters selected submenu.

6.2 Start screen after first connection

After installation and first connection, you should see a screen similar to the one shown below.

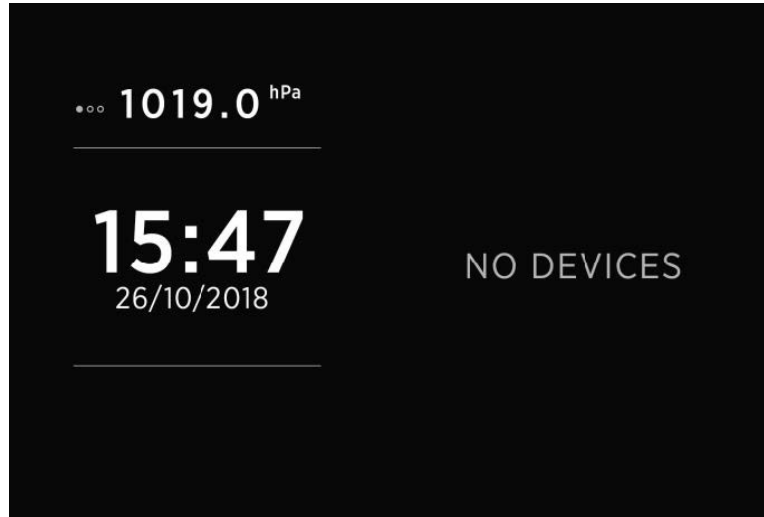

After the first power-on, there are no batteries and tanks. Long press  button to enter the settings menu.

6.3 Language settings

You can change the device's language by navigating to **GENERAL SETTINGS > LANGUAGE**. You can choose between English, German, and French language. More languages will be added with future firmware updates.

6.4 Units

You can change units by navigating to **GENERAL SETTINGS > UNITS**. There, you can select your preferred units for temperature, tank volume and altitude measurements.

6.5 Battery configuration

PICO shows all properly configured batteries. Each correctly configured battery will automatically show up on PICO. The following section describes how to set up a battery on PICO.

6.5.1 Add new battery

The following steps are equal for **SC303, SC302T, SC503**, digital shunts.

In the settings menu, navigate to **DEVICES > BATTERIES**.

Select “**Add new**” and fill in the requested data.

- Name the battery/battery bank accordingly (STARTER, SERVICE, MAIN, etc.)
- Select the battery type (Wet low maintenance, Wet maintenance free, AGM, Deep cycle, Gel, LiFePO4)
- Fill in the battery capacity for the next C ratings: C/20, C/10, and C/5. If you don't know all the ratings, fill in just those ratings that you know. It is highly recommended to fill at least two C ratings (one is not enough for precise calculations). A “C” rating is simply a battery's capacity (or Ah/amp hour rating) when discharged over a specific period. Usually, the “C” rating is specified on the battery label. For correct operation, set unknown ratings as “Not set”!
- Select a voltmeter connected to the battery. You can see only voltmeters that are not already used by other battery configurations.

SETTINGS

< VOLTMETERS

| | |
|-----------------------|---------------------|
| PICO INTERNAL | 11.851 ^v |
| SC500 [0216735249] | 12.428 ^v |
| ST107 [0167137256] U1 | 0.000 ^v |
| ST107 [0167137256] U2 | 0.000 ^v |
| ST107 [0167137256] U3 | 0.000 ^v |

- Select the current sensor connected to the battery. You can select only current sensors that are not already used by an existing battery configuration. For a battery configuration without a shunt, leave current sensor empty.
- Select a temperature sensor if you have one installed.

- Confirm and save the battery configuration with **↩** button. The newly added battery should now be visible on one of the Pico's screens once you exit the settings menu.

6.6 Tank configuration

PICO shows all properly configured Tanks. Each configured Tank will automatically show up on PICO. The following section describes how to set up a tank on PICO.

Below is an example image of how the tanks menu looks like on PICO.



6.6.1 Add new Tank

The following steps are equal for **SCQ25T/SC302T/ST107** modules. It is required to install your module of choice properly. Find the installation described in the corresponding module manual. After successfully installing the module, you can configure the tank by following these steps:

In the settings menu, navigate to **DEVICES > TANKS**.

Select "**Add new**" and fill in the requested data.

- NAME - Name the tank accordingly (FRESH WATER, WASTEWATER, FUEL 1, etc.)
- TYPE - Select the tank type (WATER, FUEL, WASTEWATER), which defines the color of the tank on Pico's screen.

- SENSOR TYPE - Select the used sensor type (RESISTANCE or VOLTAGE)
- SENSOR - Select the used sensor from the list.

SETTINGS

< OHMMETERS

| | |
|-----------------------|-------|
| SC500 [0216835249] | 10060 |
| ST107 [0167137256] R1 | 65535 |
| ST107 [0167137256] R2 | 65535 |
| ST107 [0167137256] R3 | 65535 |
| ST107 [0167137256] R4 | 404 |

- CAPACITY - Input the full tank capacity.
- CALIBRATION POINTS - Add calibration points for different tank levels. For a proper configuration at least two calibration points are required. More calibration points will enable the PICO to show **tank levels more accurately**. Added can be up to 11 calibration points. Set for each calibration point, the tank fill volume (liters or gallons) and a corresponding sensor value (resistance or voltage).
- Confirm and save the tank configuration with  button.

The newly added tank should now be visible on one of the Pico's screens, once you exit the settings menu (visible on the main menu screen).

6.7 Displaying battery, tank, temperature, barograph, inclinometer measurements and alarms

You can switch between different screens by pressing the up or down arrow buttons. There will be a separate screen for each battery with at least one connected current sensor (shunt). Multiple batteries without a current sensor (measuring voltage only) may join on a single screen.

Up to four tanks and four thermometers will join on a single screen. If there are more, they will divide into two or more screens. There is also a separate barograph screen on PICO (not on PICOone).

6.7.1 Batteries screen

Screens for showing battery data differ depending on how many current sensors are connected to a certain battery. If the battery connects only to a voltage sensor (without a current sensor), the battery name, approximate state-of-charge (SOC) and current-voltage are displayed. The calculation of SOC takes some time, so it may not be shown immediately after power-on.

Up to three batteries without a current sensor can be shown on a single screen. If there are more, they divide into two or more screens.

If the battery is connected to a voltage sensor and a single current sensor (shunt), some additional data are displayed: time to charge, time to discharge and electrical current (amps). SOC can be calculated more accurately if a current sensor is connected. Time to discharge is calculated by using an average consumption during some period. If there is more than one current sensor (shunt) connected to the battery (e.g., for monitoring different consumers or generators, connected to the battery), their data (amps) is also shown on the battery page.

! PICO's algorithm for calculating state-of-charge (SOC) is not a simple Ah- counter. It is constantly monitoring battery current, voltage, and temperature. These data are compared to the internal battery model, and its parameters are constantly being adjusted so that the model fits the actual data. The algorithm needs some time to adjust the parameters (learning phase), and it will improve accuracy during the first few cycles.



6.7.2 Tanks screen

Tanks screen shows the current level of connected and properly configured tanks. Up to four tanks can be displayed on a single screen. If there are more, they divide into two or more screens. For each tank, you can find its name, graphical representation of the current level, and numerical values of the current level as a percentage and as volume unit (liters, gallons).

Depending on the selected tank types, they represented with different colors.

Tank order, colors, names, capacities and capacity units may be changed in the settings menu.

If the tank sensor isn't selected in the tank settings or the sensor disconnected from the PICO system, the "OFFLINE" symbol will appear on the screen. If this situation occurs, check the sensor setting of the tank. If a sensor is selected, check if all the cables are properly connected.



6.7.3 Temperatures screen

Temperatures screen shows current temperatures of connected and correctly configured temperature sensors. Up to four temperature sensors can be shown on a single screen. If there are more, they divide into two or more screens. For each sensor, you can find its name, graphical representation of the current temperature, and the numerical value of the current temperature in the chosen unit (°C or °F).

Thermometer order, names, min. and max. ranges and temperature units may be changed in the settings menu. If the temperature sensor is not selected in the temperature sensor settings or the sensor is disconnected from the PICO system, the “OFFLINE” symbol will appear. If this situation occurs, please check the temperature sensor setting. If a device is selected, please check if all the cables are properly connected.

6.7.4 Barograph screen

The symbol on the left shows the current air pressure trend. The arrow shows trend direction (up – rising or down – falling). If the pressure is increasing or decreasing rapidly (1.0 mbar/h or more), two arrows are shown.

Below the trend symbol, two values show the current trend and current sea level pressure.

You can find the barograph on the right side.

The default interval for the barograph can be changed in the settings menu (**BAROGRAPH > TIME INTERVAL**). However, you can also manually switch between different time intervals on the barograph screen by shortly pressing the  button.

! The screen is only available on PICO. There is no barograph support on PICOone.

6.7.5 Inclinometers screen

If you have an inclinometer installed, the “Inclinometers screen” shows your pitch and roll data.

Pitch is shown on the left side of the screen. The left side of the line represents the front of the vehicle or boat (bow), while the right side of the line represents the back of the vehicle or boat (stern).

The pitch angle in degrees is shown below the line (positive value meaning front facing up and vice versa).

Roll is shown on the right side of the screen. The left side of the line represents the left-hand side of the vehicle or boat. The roll angle in degrees is shown below the line (positive value meaning left-hand side up and vice versa).

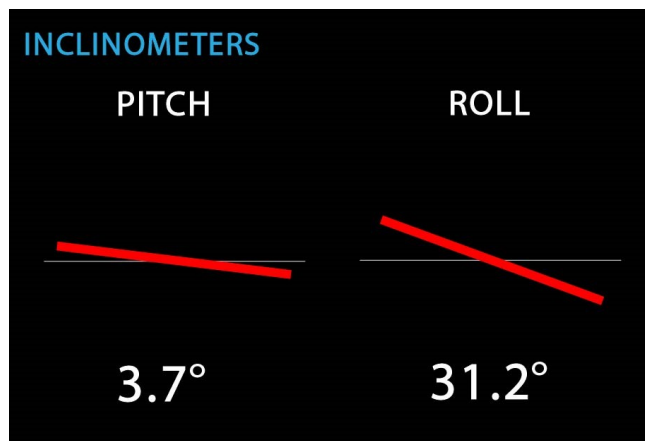

6.7.6 Alarm screen

When an alarm is triggered it is shown on PICO (see image below). From there you can control the alarm state:

- **Hide**, which hides the alarm from the display, but it is still active in the background. The output is active (if setup).
- **Snooze**, for 5 or 30 minutes, which means it is hidden for 5 or 30 minutes and then displayed again if still active. The output is active (if setup).

- **Dismiss**, turns the alarm and output (if setup) for 24h off. When multiple alarms are active, at the same time, then they are alternately displayed.



If at least one alarm is active, then an alarm entry on top in the menu settings is displayed. From there you can view all currently active alarms.

6.8 Device configuration

You can enter the settings menu by long pressing the  button. To navigate through the list, use up and down arrow buttons. To select an item, press the **enter button**. To navigate one level back, use **the back button**.

6.8.1 General settings

This menu offers screen, language, units and sleep settings.

6.8.1.1 Screen



6.8.1.1.1 Auto brightness

When auto-brightness is enabled, Pico's internal light sensors automatically adjust the screen brightness to match the ambient lighting conditions.

6.8.1.1.2 Brightness

The brightness level used during normal operation. When AUTO BRIGHTNESS is enabled, this is the maximum brightness level.

6.8.1.1.3 Min. brightness

Min. brightness has two functions.

1. When PICO is in sleep mode, the illumination is set to min. brightness level.
2. When AUTO BRIGHTNESS is enabled, it defines the minimum illumination.

6.8.1.2 Device

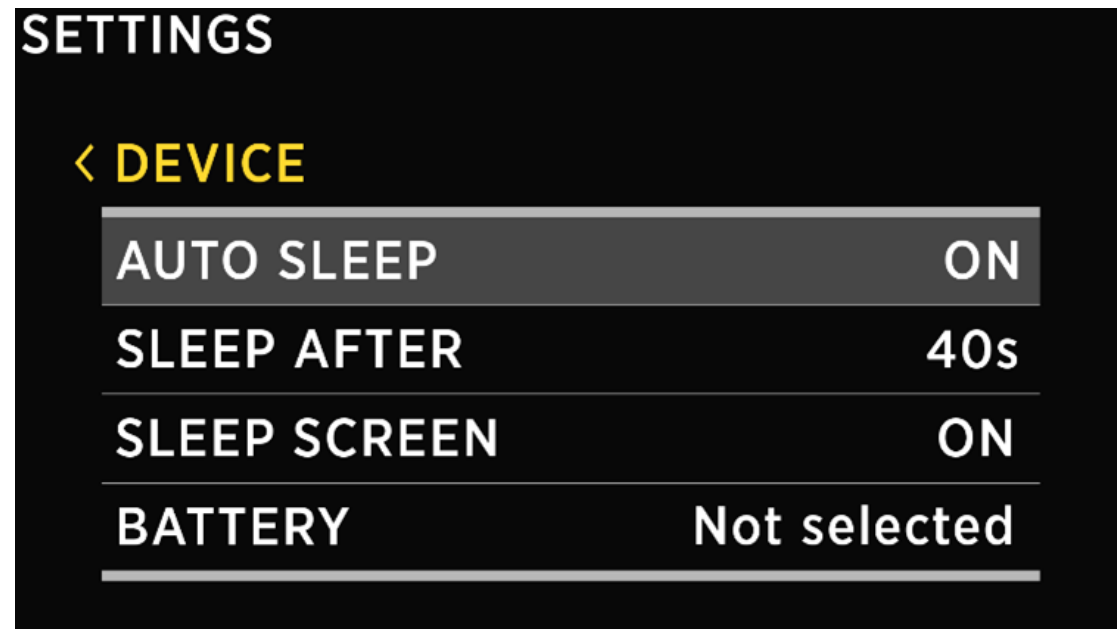

6.8.1.2.1 Auto sleep

If enabled, PICO goes into sleep mode after SLEEP AFTER time.

6.8.1.2.2 Sleep after

Time after which PICO goes into sleep mode if the AUTO SLEEP setting is enabled.

6.8.1.2.3 Sleep screen

If SLEEP SCREEN is enabled, PICO will show sleep screen if it is in sleep mode.

6.8.1.2.4 Battery

Here, you can select between the available batteries.

6.8.1.2.5 Left button

Here you can configure the left button of PICO.
You can configure the left button to function SLEEP or POWER OFF.
By holding the left button, the function will execute.

6.8.1.2.6 Power management

Here, you can enable the automatic power off and set the time when the PICO turns off automatically.

6.8.1.3 Language

You can choose between English, German and French language. More languages will be added with future firmware upgrades.

6.8.1.4 Units

You can choose different international units for pressure, **temperature**, **volume**, **altitude** and **speed**.

6.8.2 Data management

This menu enables you to set up alarms for certain measurements. Here, you can choose the quantity, the device, low and high values for alarm, and you can turn the high/ low-value alarms on and off.

- **ALARM LOW:** Low-value alarm fires when the measured value is lower than the setup **alarm value**.
- **ALARM HIGH:** High-value alarm fires when the measured value is higher than the setup **alarm value**.

After you select ALARM LOW or ALARM HIGH, the following alarm settings will appear:

- **ALARM STATE** used to enable or disable the alarm.
- **ALARM VALUE**, a limit value which fires the alarm.
- **SILENT**, if enabled, there will be no audible signal when the alarm fires. The alarm warning will only appear on PICO's screen.
- **ALARM DELAY**, the time delay with which the alarm is fired. The alarm fires when only the measured value is below (for alarm low) or above (for alarm high) the "alarm value" during the delay period.
- **ALARM DURATION**, the selected alarm duration. 5 minutes by default.
- **OUTPUT**, the digital output that is turned on during an active alarm.

6.8.3 Devices

Here, you can manage all the devices that are connected to your PICO. When you connect a new module to your PICO system (e.g., a new shunt), some new devices will automatically appear on the devices list (e.g., current sensors, voltmeters, ohmmeters...). These devices automatically appear because they are integrated into the modules. But “secondary” devices - those that are connected to the modules (BATTERIES, TANKS, THERMOMETERS, and analog INCLINOMETERS) - will not be added automatically. If you connect a new battery, tank or thermometer, you have to add and configure the new device manually in the **DEVICES** menu.

Devices are grouped into different device types. To view, manage, add or delete a certain device, please **select the corresponding device** type from the list (e.g., BATTERIES, TANKS ...).

6.8.3.1 Batteries

List of batteries which you have added to your PICO. By selecting a certain battery, you can view or change its settings, and you can delete the battery if you need to. By selecting “**Add new**” you can add a new battery.

If the battery connects only to a voltage sensor (without a current sensor), the battery name, approximate state-of-charge (SOC) and current-voltage are displayed. The calculation of SOC takes some time, so it may not be shown immediately after power-on.

Up to three batteries without a current sensor can be shown on a single screen. If there are more, they divide into two or more screens.

If the battery is connected to a voltage sensor and a single current sensor (shunt), some additional data are displayed: time to charge, time to discharge and electrical current (amps). SOC can be calculated more accurately if a current sensor is connected. Time to discharge is calculated by using an average consumption during some period.

If there is more than one current sensor (shunt) connected to the battery (e.g., for monitoring different consumers or generators, connected to the battery), their data (amps) is also shown on the battery page.

! PICO’s algorithm for calculating state-of-charge (SOC) is not a simple Ah-counter.
It is constantly monitoring battery current, voltage, and temperature. These data are compared to the internal battery model, and its parameters are constantly being adjusted so that the model fits the actual data.
The algorithm needs some time to adjust the parameters (learning phase), and it will improve accuracy during the first few cycles...

! After adding a new battery or changing settings of an existing battery, the algorithm for calculating state-of-charge (SOC) needs some time to adjust the parameters of its battery model (learning phase).
It will improve accuracy during the first few cycles.

6.8.3.1.1 Name

Here, you can view or edit the battery name.

6.8.3.1.2 Type

Here, you can view or change the battery type. Supported types are:

- WET LOW MAINTENANCE
- WET MAINTENANCE FREE
- AGM
- DEEP CYCLE
- GEL
- LiFePO4

6.8.3.1.3 Capacity

The nominal battery capacity for the next C ratings: C/20, C/10, and C/5. If you don't know all the ratings, fill in just those ratings that you know. It is highly recommended to fill at least two C ratings (one is not enough for precise calculations). A "C" rating is simply a battery's capacity (or Ah/amp hour rating) when discharged over a specific period. Usually is the "C" rating specified on the battery label or the battery datasheet.

! For correct operation, set unknown ratings as **NOT SET!**



6.8.3.1.4 Voltmeter

List of all voltmeters connected to a battery. You can see only voltmeters that are not already used by other battery configurations.

SETTINGS

< VOLTMETERS

| | |
|-----------------------|---------------------|
| PICO INTERNAL | 11.851 ^v |
| SC500 [0216735249] | 12.428 ^v |
| ST107 [0167137256] U1 | 0.000 ^v |
| ST107 [0167137256] U2 | 0.000 ^v |
| ST107 [0167137256] U3 | 0.000 ^v |

6.8.3.1.5 Ammeters

A current sensor (shunt) which connects to the battery. You can only select current sensors that are not already used by other device's configuration.

! For a battery configuration without a shunt, leave current sensor empty.

6.8.3.1.6 Temperature sensors

List of all temperature sensors in SiCOM network. You can only select sensors that are not already used by other device's configuration.

6.8.3.1.7 Range

Here, you can view or edit the battery range.

6.8.3.1.8 Advanced settings

Advanced users may adjust some additional battery settings to customize the battery data display. It is not mandatory to change these settings – the defaults should be suitable for most users.

- **TTG AVG** – averaging interval for calculating TTG (time-to-go). “Short” means that TTG will respond to the change in current more quickly, and “Very long” means that TTG will respond to the change in current more slowly.
- **TTG SOC MIN** – Target state-of-charge (%) for the time-to-go calculation during battery discharge. TTG shows the time when the battery will reach the preset TTG SOC value.
- **CEF** – charging efficiency (%).
- **DISPLAY TYPE** – “Detailed” display type also shows the amp-hour counter on the Batteries screen.

6.8.3.1.8.1 Battery full settings

Advanced users

Here, users may set additional battery fullness settings. Displaying to the user the % of battery fullness based on voltage, current and time.

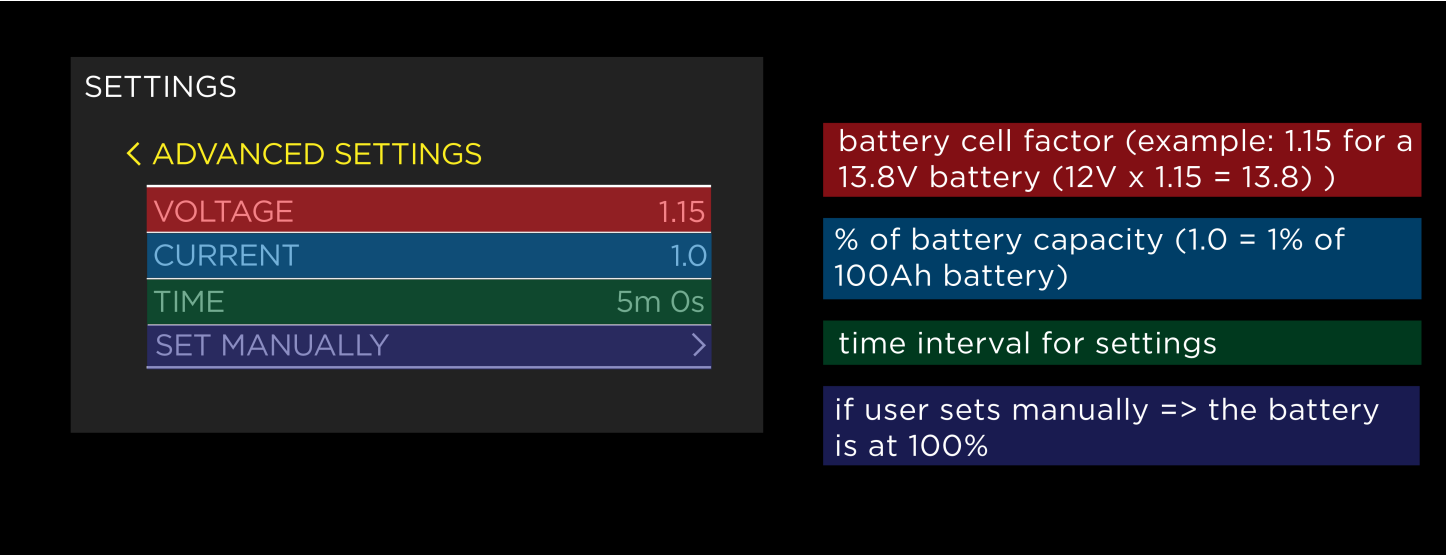

The image shows a screenshot of a settings menu titled 'SETTINGS' with a sub-menu 'ADVANCED SETTINGS'. The menu items are:

- VOLTAGE 1.15
- CURRENT 1.0
- TIME 5m 0s
- SET MANUALLY >

Explanatory text boxes on the right side of the image:

- battery cell factor (example: 1.15 for a 13.8V battery ($12V \times 1.15 = 13.8$))
- % of battery capacity (1.0 = 1% of 100Ah battery)
- time interval for settings
- if user sets manually => the battery is at 100%

Example:

- If you have a 13,8V 100Ah battery, then you can use the settings from the picture above.

- System voltage (12V) x factor (1.15) = 13,8V -> your battery.
- Battery capacity (100Ah) ... 1.0 is a % factor of the battery capacity (1.0 = 1Ah = 1%).
- Time -> This setting is a determined time interval for how long both conditions take (voltage, current) for the battery to determine the new 100% value.
- Set manually -> Select this when you are sure that the battery fullness is at 100%.

6.8.3.1.9 Instance

Here, you can view or edit the instance of the battery.

6.8.3.1.10 Delete

With this option, you can delete the selected battery

6.8.3.2 Tanks

List of tanks which you have added to your PICO. By selecting a certain tank, you can view or change its settings, and you can delete the tank if you need to.

By selecting “**Add new**” you can add a new tank.



6.8.3.2.1 Name

Here, you can view or edit the tank name.

6.8.3.2.2 Type

Here, you can view or change the tank type. You can choose between **WATER**, **FUEL**, and **WASTEWATER**. Tank type is used solely for the color that will represent the tank on PICO's screen. Each type has a different color.

6.8.3.2.3 Sensor type

You can select or change the sensor type that is used to measure the tank level. You can choose between **RESISTANCE** and **VOLTAGE** sensor types.

6.8.3.2.4 Sensor

Voltage or Resistance sensor which is used to **measure the tank level**. Here, you can view or select the corresponding sensor. You can only choose sensors that are not already used by other device's configuration.

6.8.3.2.5 Capacity

Used to set up the full tank capacity.

6.8.3.2.6 Calibration points

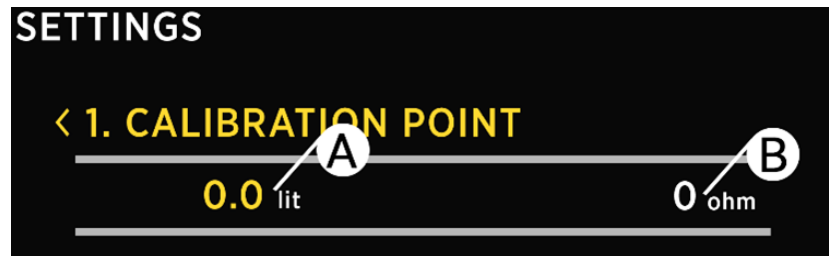

Here, you can view the list of calibration points for the tank. You can also add new calibration points or remove existing ones. If you are adding a new tank, at least two calibration points have to be added for a proper configuration. More calibration points will enable PICO to show tank level more accurately. Up to 11 calibration points can be added. For each calibration point, tank fill volume and a corresponding sensor value (resistance or voltage) must be set.



A - **Fill volume** of a tank [liters/gallons]

B - **Sensor value**, resistance [ohms] or voltage [volts]

To add a new calibration point:

- select CALIBRATION POINTS > Add New
- Two values will appear on the screen. The value on the left shows the tank fill volume, and the value on the right shows the corresponding sensor value (resistance in ohms or voltage). Press  to set up a tank level. The left value turns yellow.
- Use arrow buttons to input the desired tank level in liters or gallons. Press  to confirm the value.
- Now, the right value (resistance or voltage) turns yellow. A menu pops up which allows you to choose:

MEASURED VALUE: use currently measured value by the selected sensor (resistance or voltage).

INPUT VALUE: when selecting this item, you can manually enter the desired value (resistance or voltage).

DELETE: when selecting this item, the calibration point is deleted.

6.8.3.2.7 Display priority

This setting enables you to choose between the following display priorities: **HIGH, MEDIUM, LOW** and **HIDE**. The SPDU-52 Tank has a 25%, 50%, 75% and 100% indicators.

Use display priority for ordering the tanks on PICO's screen. When tanks are shown on the screen, those with HIGH display priority are shown first (leftmost), followed by tanks with MEDIUM display priority. Tanks with LOW display priority are shown last. If you select HIDE, this tank's level will not be shown on the Tanks screen (it will be hidden).

6.8.3.2.8 Delete

With this option, you can delete the selected tank.

6.8.3.3 Temperature sensors

List of temperature sensors which you have added to your PICO. By selecting a certain sensor, you can view or change its settings, and you can delete it if you need to. By selecting “**Add new**” you can add a new temperature sensor.

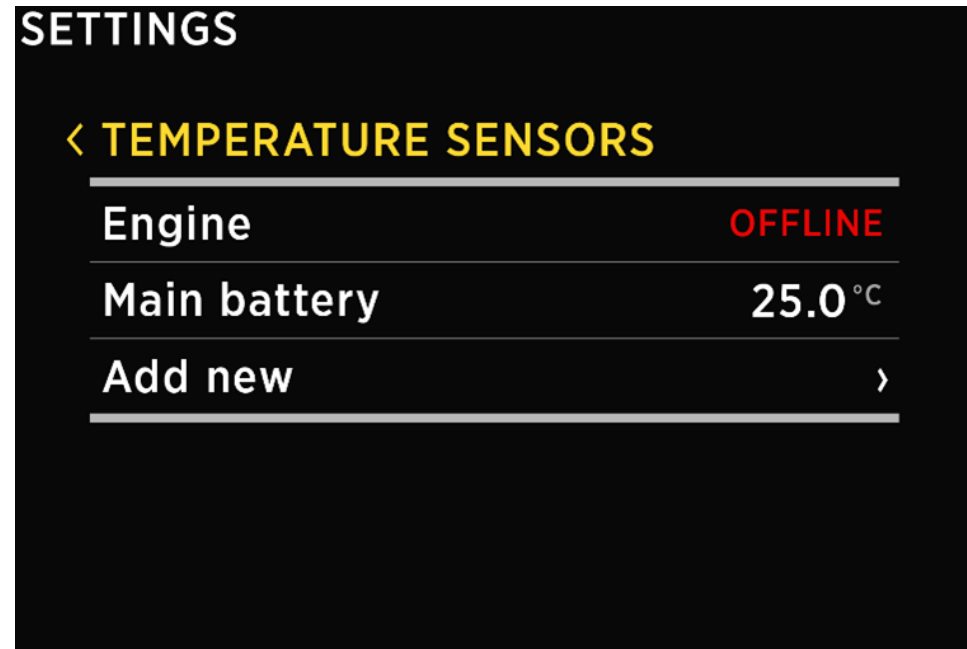

6.8.3.3.1 Name

Here, you can view or edit the temperature sensor name.

6.8.3.3.2 Type

Here, you can view or change the temperature sensor type. Supported models: NTC 10K and NTC 5. These are 10kOhm and 5kOhm thermistors with a negative temperature coefficient.

6.8.3.3.3 Device

The device and input to which the sensor is connected. For example: if the sensor is connected to the ST107 module and its input R1, select the option **ST107 [serial number] R1**.

6.8.3.3.4 Display priority

This setting enables you to choose between the following display priorities: **HIGH**, **MEDIUM**, **LOW** and **HIDE**.

The display priority is used for ordering the thermometers on PICO's screen. When thermometers are shown on the screen, those with **HIGH** display priority are shown first (leftmost), followed by thermometers with **MEDIUM** display priority. Thermometers with **LOW** display priority are shown last. If you select **HIDE**, this thermometer's level will not show up on the Temperatures screen (it will be hidden).

6.8.3.3.5 Range MIN

PICO shows thermometer with a graphical representation (vertical bar), together with the current numerical value. This option defines minimum value (temperature) of the thermometer bar.

6.8.3.3.6 Range MAX

PICO shows thermometer with a graphical representation (vertical bar), together with the current numerical value. This option defines maximum value (temperature) of the thermometer bar.

6.8.3.3.7 Calibration

This setting enables you to calibrate the sensor value. If the displayed value is too high, you can use a negative calibration value (offset). If the displayed value is too low, you can use a positive calibration value (offset).

6.8.3.3.8 Delete

With this option, you can delete the selected temperature sensor.

6.8.3.4 Current sensors

List of all current sensors (shunts). Connected current sensors are added to the list automatically. You cannot manually add a new current sensor. In this list, you can view current readings (amperes) for all connected current sensors. By selecting a certain sensor, you can **view** or **change** its settings.

SETTINGS

< CURRENT SENSORS

| | |
|---------------------|--------------------|
| SC500[0216835249] | -1.01 ^A |
| SCQ25[0437773054] 1 | 1.04 ^A |
| SCQ25[0437773054] 2 | 0.00 ^A |
| SCQ25[0437773054] 3 | 0.00 ^A |
| SCQ25[0437773054] 4 | 0.00 ^A |

6.8.3.4.1 Name

Here, you can view or edit the current sensor name.

6.8.3.4.2 Range

PICO shows the current sensor with a graphical representation (horizontal bar), together with the current numerical value. This value defines the maximum value (amps) for the horizontal bar.

6.8.3.4.3 Reverse current

If you swap the wires on the shunts terminals, PICO will show the opposite value of the current. E.g., when discharging, PICO will show charge current and vice-versa. In such a situation, you can use this setting to reverse the current value. If you set this value to **ON**, PICO will reverse the measured value.

6.8.3.4.4 Add current

There can be multiple current sensors (shunts) connected to a single battery. With this setting, you can define which currents must be added together to get the total current on a certain battery. Set this value to ON for all the shunts which should be added together to calculate the total current on the battery. Set this value to OFF for all the other shunts.

Example 1: One sensor may monitor the total current on the battery, and other sensors may be used to monitor certain consumers or generators. Set this value to ON for the sensor which monitors the total current on the battery. Set this value to OFF for all the other sensors.

Example 2: Three shunts may be connected to the battery in parallel, to monitor the consumption in three different branches. To summarize the total current on the battery, the currents of all three shunts must be added together. In such scenario, set the value to ON for all three shunts.

6.8.3.4.5 Battery

Used to select the battery to which the sensor is connected.

6.8.3.4.6 Display separately

By default, this option is turned off. If the option is on, the current value displayed on a separate screen dedicated to current values. Up to 12 current values can be displayed at the same time on one screen.

6.8.3.4.7 Display priority

This setting enables you to choose between the following displays priorities: **HIGH, MEDIUM, LOW and HIDE.**

Use the display priority for ordering the current sensors on PICO's screen. When current sensors are shown on the screen, those with **HIGH** display priority are shown first (at the top), followed by sensors with **MEDIUM** display priority. Sensors with **LOW** display priority are shown last (at the bottom). If you select **HIDE**, this sensor will not show up on the Batteries screen (it will hide).

6.8.3.4.8 Device

Displays device name, serial number, and port. **Device name [serial number] port.** Example: SC503[12345678]

6.8.3.4.9 Merge with

The function allows you to combine two or more current sensors and add up currents together. Simply select from the list to which current sensor you want to connect the sensor.

Example: when using an SCQ25 module you can merge 2, 3 or all 4 shunts and consequently we have a 100A (4x25A) shunt. It is possible to merge current sensors that are not on the same device.

6.8.3.5 Voltmeters

List of all voltmeter sensors connected to your PICO. Connected voltmeters are added to the list automatically. You cannot manually add a new voltmeter. In this list, you can view current readings (voltages) for all connected voltmeters.

SETTINGS

< VOLTMETERS

| | |
|-----------------------|---------------------|
| PICO INTERNAL | 11.851 ^V |
| SC500 [0216735249] | 12.428 ^V |
| ST107 [0167137256] U1 | 0.000 ^V |
| ST107 [0167137256] U2 | 0.000 ^V |
| ST107 [0167137256] U3 | 0.000 ^V |

6.8.3.6 Ohmmeters

List of all ohmmeters connected to PICO. Connected ohmmeters are added to the list automatically. You cannot manually add a new ohmmeter. In this list, you can view current readings (resistance in ohms) for all connected ohmmeters.

6.8.3.7 Coulomb counter

For each connected current sensor, a corresponding Coulomb counter will also appear on the devices list. Each Coulomb counter shows a total electric charge (in Ah, amp hours) that has transferred through this sensor until now. By selecting a certain Coulomb counter, you can manually reset the counter to zero.

6.8.3.8 Inclinometer

List of inclinometer sensors which you have added to your PICO. By selecting a certain sensor, you can view or change its settings, and you can delete it if you need to. By selecting “**Add new**” you can add a new analog sensor with voltage output.

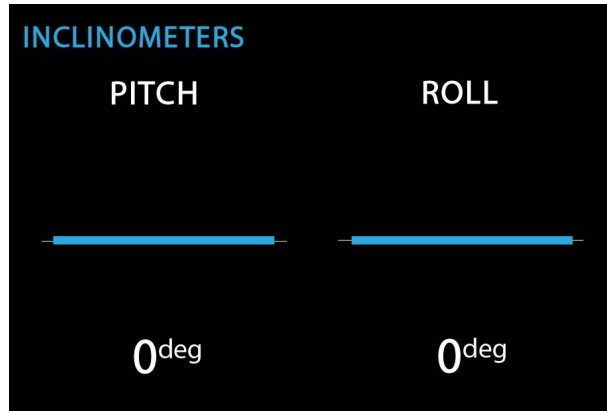

6.8.3.8.1 Name

Here, you can set the inclinometer sensor name to “Pitch” or “Roll”.

6.8.3.8.2 Style

You can choose between different graphical representations of the inclinometer on the mobile app: line, caravan or camper. Note that this setting is only available on the mobile app.

6.8.3.8.3 Sensor

The analog (voltage) input to which the analog sensor is connected.

6.8.3.8.4 Nonlinear

You can enable or disable a nonlinear display of the angle. If the nonlinear setting is disabled, the line on the screen is plotted exactly at the (true) pitch or roll angle. Since it might be difficult to distinguish small angles, you can enable the nonlinear display of the angle. In this mode, the line is plotted at a greater angle if the true pitch or roll angle is small. While it is much easier to observe small angles and small changes in this mode, the angle of the line does not represent the true angle (it is exaggerated).

6.8.3.8.5 Calibration

Used to **calibrate the analog sensor**. You can set voltage for zero point (angle 0°) and steps (millivolts per degree).

6.8.3.8.6 Display

With this setting, you can show or hide the inclinometer on PICO's screen.

6.8.3.8.7 Reverse

If the inclinometer shows the inverse value for pitch or roll angle (e.g., left instead of right), you can enable this option to reverse the display.

6.8.3.8.8 Delete

With this option, you can delete the selected inclinometer sensor.

6.8.3.9 User Sensors

List of custom sensor which you have added to your PICO. By selecting a certain sensor, you can view or change its settings, and you can delete the sensor if you need to. By selecting "**Add new**" you can add a custom user sensor.

6.8.3.9.1 Name

Here, you can view or edit the the user sensor name.

6.8.3.9.2 Voltmeter

Here, you can view and select a connected device, to which you have wired your custom device to. The custom device which you want to select, must be wired to a SC device with voltage output (U1 or U2,...).

6.8.3.9.3 Range MIN

This option defines the minimum value of the sensor. Presented via graphical representation (vertical bar), together with the current numerical value. This option defines the minimum value of the custom user sensor.

6.8.3.9.4 Range MAX

This option defines the maximum value of the sensor. Presented via graphical representation (vertical bar), together with the current numerical value. This option defines the maximum value of the custom user sensor.

6.8.3.9.5 Decimals

Used to set the number of decimal points. The option '0' is the default value for integers (numbers with no decimal values).

6.8.3.9.6 Measurement unit

Used to set the custom measurement unit.

6.8.3.9.7 Low voltage point

Used to change the value of the **LOW** voltage point in volts. The lowest number you select will correspond with the minimum range maximum range.

You can set voltage for any number of points. The number you select, will be defined as the minimum point of the user device.

6.8.3.9.8 High voltage point

Used to change the value of the **HIGH** voltage point in volts. The highest number you select will correspond with the minimum and maximum range.

You can set voltage for any number of points. The number you select, will be defined as the maximum point of the user device.

6.8.3.9.9 Delete

With this option, you can delete the selected user sensor.

6.8.4 WI-FI

This menu offers all the Wi-Fi settings for your PICO.

6.8.4.1 Operation

When set to ON, Wi-Fi module is enabled. Otherwise, it is disabled, and no configuration data is displayed.

6.8.4.2 Mode

The PICO supports **AP** mode which stands for the **access point** and **STA** mode for **station mode**.

6.8.4.2.1 STA MODE

When in STA mode, you can connect PICO to your local router and connect with your smartphone via a router. This mode enables more than one mobile app connecting to PICO at the same time. To set up STA mode take the following steps:

- Under MODE select STA mode.

- Under SSID find and select your router.
- PICO detects the security type, select password, and type in the WIFI password.
- After this select connect and wait for PICO to connect.

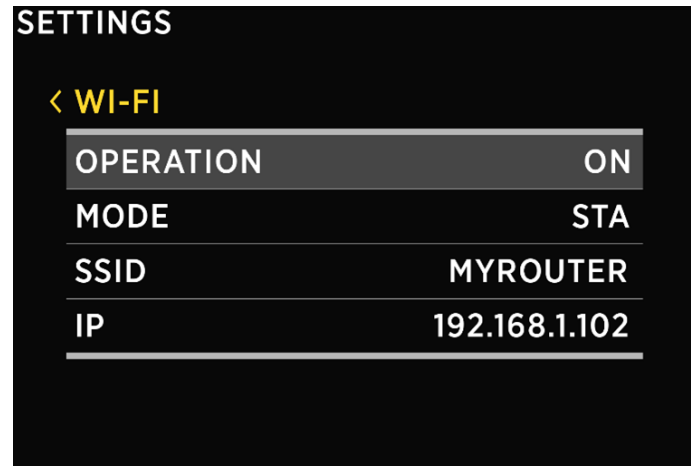

! If the PICO can't find your router SSID, check if SSID broadcasting is enabled on your router.

! The Dynamic Host Configuration Protocol (DHCP) should be enabled on the router to assign an IP address dynamically.

6.8.4.2.2 AP Mode

When in AP mode, the PICO creates its wireless network. If you want to connect to PICO with your smartphone, please connect to the network whose name corresponds to SSID setting value. Wireless network password can be changed with PASSWORD setting. The default password is **pico<first four digits of the serial number>**. Example: if your PICO's serial number is 12345678, then the default Wi-Fi password is pico1234.

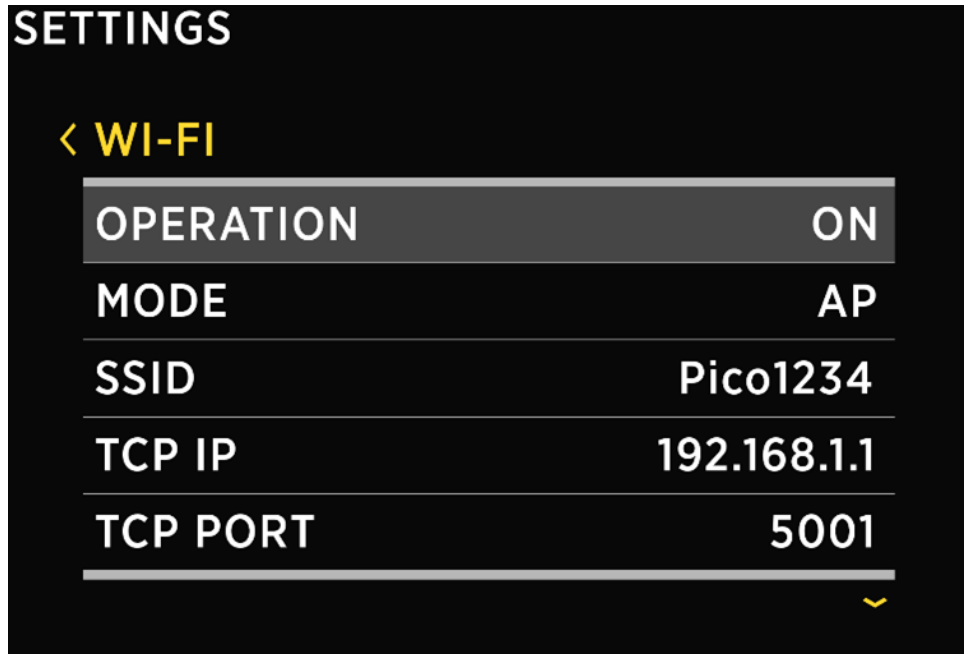

6.8.4.3 SSID

SSID stands for Service Set Identifier.

In AP Mode, it is the Wi-Fi network name that is created by PICO. Default SSID is **PICO<last four digits of the serial number>**.

Example: if your PICO's serial number is 12345678, then the default Wi-Fi SSID is **pico5678** or . You can change the SSID it. You can find the serial number on the sticker on the back side of PICO or in the menu under **SYSTEM > SYSTEM INFO**.

6.8.4.4 TCP IP

Shows the default IP of your PICO.

6.8.4.5 TCP PORT

Shows the default TCP port for communicating with the PICO.

6.8.4.6 UDP IP

Shows the default IP to which UDP live data packets are sent.

6.8.4.7 UDP PORT

Shows the default UDP port for communicating with your PICO.

6.8.4.8 Password

Default password: **pico<first four digits of the serial number>**

Example: if your PICO's serial number is 12345678, then the default Wi-Fi password is pico1234.

You can find the serial number on the sticker on the back side of PICO or in the menu under **SYSTEM > SYSTEM INFO**.

This is the default password, and you can change it.

You cannot see the current password on the menu, but you can change it by selecting the PASSWORD setting. Minimum password length is 8 characters.

6.8.4.9 WIFI reset

This option restarts the WIFI settings for your PICO.

6.8.5 Date & Time

In this menu, you can set the time, date, and time zone manually, but we do not recommend to do it, because these values will be overridden by your smartphone settings each time you connect the phone to your PICO and start Pico application.

The exact time is important for the proper functioning of the device, and hence it is synchronized with your phone on each connection.

However, time format and date format settings can be changed freely as your phone settings will not override these.

6.8.5.1 Time

Set the current time. The value is overridden each time you connect the phone to your PICO and start PICO application.

6.8.5.2 Date

Set the current date. The value is overridden each time you connect the phone to your PICO and start PICO application.

6.8.5.3 Time zone

Set the current time-zone. This value is overridden each time you connect the phone to your PICO and start PICO application.

6.8.5.4 Time format

You can choose your desired time format from the list.

6.8.5.5 Date format

You can choose your desired date format from the list.

6.8.6 Service

6.8.6.1 Settings locked

Here, you can lock the settings of the PICO. A PIN will be required to unlock the settings in the future. To lock the settings of the PICO, select **ON**, to keep the settings unlocked, select **OFF**.

6.8.6.2 Main screen

Change what will be displayed on the main screen.

6.8.6.3 Debug screen

Opens the debug menu, listing all the services and displaying whether the service is running (1) or not (0).

6.8.7 System

6.8.7.1 Communication devices

List of all the devices (modules) that are connected to the PICO, together with the bus communication quality (%).

6.8.7.2 System info

Displays PICO's serial number, currently installed **firmware version** and **free memory**.

6.8.7.3 System reset

Deletes all the devices from the PICO.



7. Mobile App

Your smartphone can remotely control PICO via Wi-Fi connection. Using the app, you can monitor current (live) data for the batteries, tanks, thermometers, and barograph. You can also change the PICO settings on your smartphone, and easily upgrade **Simarine firmware** to a new version when it becomes available.

Find your **Simarine - application** in your mobile store by scanning the QR code below or visiting below link for your app store.



<https://play.google.com/store/apps/details?id=net.simarine>



<https://itunes.apple.com/us/app/PICO-battery-monitor/id1217159039>



The **Android** application also includes a Widget which displays basic battery, tank and thermometer data. If you want to use the widget, you can add it to your home screen. To add a widget, find a blank space on your home screen, then touch it and hold until an option “Widgets” appears on the screen. Touch the “Widgets” option and then select Simarine PICO Widget from the list. Please note that the widget only updates the data every few minutes to save your phone’s battery.



8. Save and restore settings

Using your mobile app, you can save your current PICO settings to your phone, and you can restore your saved settings from your phone to your PICO.

Save settings. To save settings, open your PICO mobile app and connect to your PICO. In the SETTINGS menu, choose **SAVE / RESTORE SETTINGS > SAVE CURRENT SETTINGS**. Name your settings and tap **OK**. Your settings are then saved.

Restore settings. If you want to restore your Caravan Panel's settings, open your PICO mobile app and connect to your PICO via Wi-Fi. In the SETTINGS menu, choose **SAVE / RESTORE SETTINGS > RESTORE SETTINGS**. A list of saved settings will appear, together with a date and time when these settings saved. Select a desired record from the list and tap **RESTORE**. You will be asked to confirm your action. After pressing **RESTORE** once again, wait a few seconds for your settings to restore.

! You can restore to your previously saved settings if your PICO's physical configuration has not been changed (no shunts or modules have been added or removed). If your PICO's physical configuration has changed, you will not be able to restore to the settings that had been saved before the configuration has changed.

If you use the same PICO physical configuration (the same number of modules and shunts) on multiple caravans, it is also possible to transfer the settings from one caravan to another by using the same procedure.

The application also creates **automatic backup** of your previous settings when you modify your settings. These backups will also be shown on the **list of available saved settings** when you choose to restore settings.



9. Firmware upgrade

To ensure the best PICO experience, we recommend upgrading Caravan Panel's firmware to the latest version. You can do this via **Simarine application**, available on your smartphone application market as described in chapter 7 - Mobile App.

! It is important to install the latest Simarine Application (or to update your installed application to the latest version) before proceeding with the firmware upgrade.

The upgrade process requires the following steps:

1. **Install or update** the Simarine application - **Simarine application** on your smartphone.
2. Turn on **Wi-Fi** on your PICO.
3. Connect your smartphone to PICO via Wi-Fi.
4. Launch the **PICO** application on your smartphone and click **LIVE VIEW**.
5. Go to the settings menu and tap > **DEVICE SETTINGS > FIRMWARE UPGRADE**. Confirm the upgrade in your App. The upgrade process will put your PICO device in the **upgrade mode**.
6. Long press the **⏻** button on your PICO to confirm the firmware upgrade on your PICO. The upgrade process can take a few minutes to complete.
7. After the upgrade, PICO reboots and is ready to use.

If there is no FIRMWARE UPGRADE option in the application menu (step 5), please make sure that you have **updated** your App to the **latest version**.

10. Technical specifications

| | |
|--|---|
| Operating | |
| Voltage range | 6 – 35 V |
| Temperature range | -10 – +70 °C (+10 – +160 °F) |
| Power consumption at 12V | |
| Operating, Wi-Fi on, 100% illumination | 90 mA |
| Operating, Wi-Fi off, 70% illumination | 35 mA |
| Stand by, Wi-Fi off, 0% illumination | 18 mA |
| Power off, Logger still active | 5 mA |
| Resolution | |
| Current | ± 0.01 A |
| Voltage | ± 0.01 V |
| Amp hours | ± 0.1 Ah |
| State of charge (0 - 100%) | ± 0.1 % |
| Temperature | ± 0.1 °C/°F |
| WIFI | |
| Radio frequency bands | 2.4 GHz |
| Dimensions (without connector) | |
| PICO | 157.10 x 82.10 x 5.60 mm 6.18 x 3.23 x 0.22 in |
| Connectivity | |
| Batteries | 6 |
| Shunts | 24 |
| Temperature sensors | 10 |
| Tank level sensors | 14 |
| Inclinometer sensors | 2 |
| Smartphone application | 1 |
| Logger capacity | up to 3 months |



SIMARINE

Safe Voyage.